

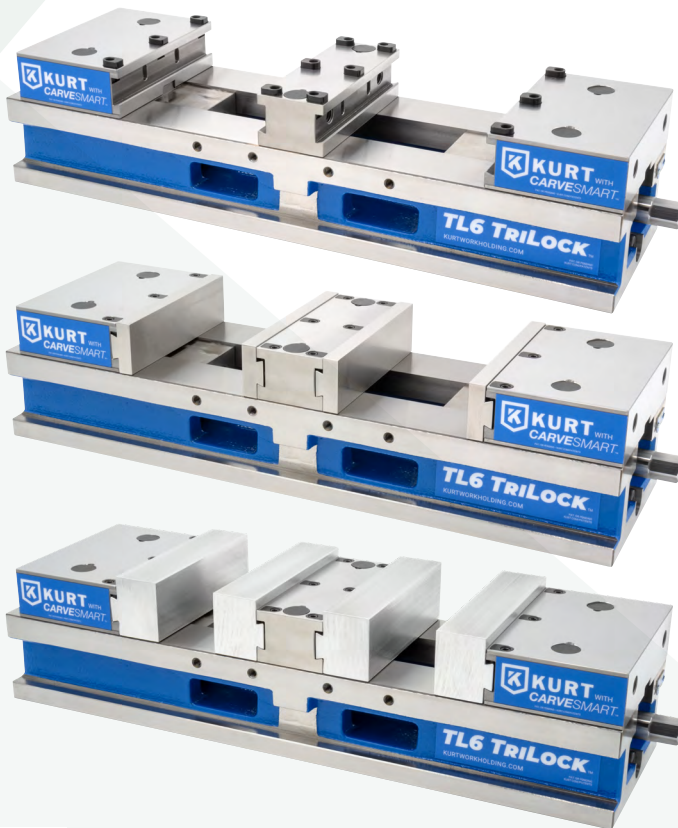

**KURT** WORKHOLDING

# TL6CS TRILOCK 3-IN-1 VISE WITH CARVESMART JAWS

Operating Instruction Manual - TL6CS / TL6CSP



**WATCH PRODUCT  
SETUP VIDEO**

Scan Code with  
Phone Camera

**ENGLISH**

# TABLE OF CONTENTS

Introduction .....	3
Set-Up Instructions .....	4
Installation Instructions .....	5
Operating Instructions.....	6-19
TL6CS Parts List.....	20
TL6CS Mechanical Drawing.....	21
Maintenance Schedule.....	22
Troubleshooting Tips.....	23
Maintenance Log/Notes .....	24-26
Warranty.....	27

## WISE DATA

Use this to fill out information about your vise for quick reference.

Purchase Date: \_\_\_\_\_ - \_\_\_\_\_ - \_\_\_\_\_

Purchase Order: \_\_\_\_\_

Purchased From: \_\_\_\_\_

Delivery Date: \_\_\_\_\_

Serial No.: \_\_\_\_\_

**NOTE: MAKE SURE TO REGISTER YOUR WARRANTY ONLINE AT [KURTWORKEHOLDING.COM](http://KURTWORKEHOLDING.COM)**

# INTRODUCTION

Thank you for purchasing a Kurt TL6CS TriLock 3-in-1 vise. You have just purchased one of the best machine vises in the industry. The outstanding accuracy of this product is second to none. Backed by a lifetime warranty against workmanship and material defects, this product is built to last when used and maintained properly.

The original Kurt AngLock vises are designed for precision clamping on basic machine tools such as knee-type mills, and machining centers. They can be used for, but are not limited to, operations like precision boring, drilling, tapping and finishing.

The patented AngLock design allows the movable jaw to advance in such a way that each pound of force forward induces a 1/2 pound of force downward which minimizes the jaw lift and increases accuracy (Fig.1). Other features include: 80,000 psi ductile iron body, hardened vise bed & jaw plates, and a semi-hard steel screw.

Fig.1

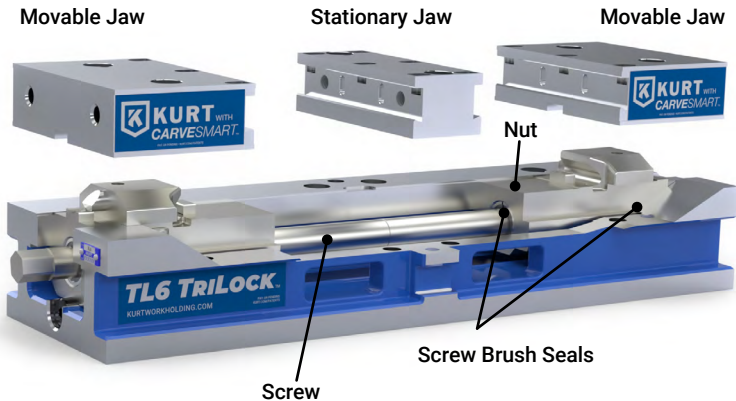

# SET-UP INSTRUCTIONS

Now that you have your new Kurt Vise, it's time to set-up and begin using it. You will see that your new vise comes with a Kurt swivel handle. The handle is specifically designed to provide maximum torque to your vise (clamping force provided below). Your vise should be mounted to a clean, flat surface. The surface and the vise must be free of any chips, dirt, or debris of any kind. The mounting surface can be honed if necessary. Clean the bottom of the vise with solvent or another cleaner if needed.

To minimize vise bed deflection, clamp your Kurt vise to your machine table, pallet, or sub-plate using toe clamps.

Additional clamping can be used, but may not be necessary. Please be sure to exercise good judgment when securing your vise to the mounting surface. Be sure your vise is secured and will not move when applying cutting pressure.

TL6CS	
TORQUE FT-LBS	FORCE IN LBS.
10	640
20	1,230
30	1,710
40	2,350
50	3,080
60	3,750
70	4,470
80	4,980
90	5,550

# WISE INSTALLATION INSTRUCTIONS



CAUTION

Do not attempt to lift the vise by attaching to any of the jaws or injury may result. Always attach lifting devise to the vise base frame.

1. Position vise on your machine table, pallet or tombstone using the 0.625" locating holes found on the bottom of the vise. We recommend using the holes that are the farthest apart for better accuracy.
2. Bolt in place using strap clamps placed on the clamping ledge.
3. After the vise is mounted in place, add the vise jaws to the base assembly.

**NOTE:** For exact hole locations, go to page 18 in this manual.

# OPERATING INSTRUCTIONS

For proper vise operation, insert the handle on to the hex end of the vise. Rotate clockwise to clamp and counterclockwise to unclamp your vise. This handle, combined with the correct amount of torque, will provide you with all the clamping force you will need to machine your parts. Kurt suggests using a torque wrench set to any of the torque specifications listed on page 4 to ensure repeatable clamp force.

**DO NOT** use any other type of pressure to open or close your vise.

**The uses of handle extensions, air impact wrenches, breaker bars, or hammer strikes are not recommended and will void the warranty if used. This will also cause damage to the screw threads. If you need more clamping force you may require a larger vise.**

## **One-Sided Clamping:**

To properly clamp a part in your Kurt double-station vise, you should place the parts in the center of the jaws resting on the ways of the vise. Clamping only on one side or above the movable and stationary jaws can result in jaw lift or loss of accuracy. (See Fig.2 on page 7)

If one-sided clamping is necessary, you **MUST** use a dummy part on the other side. When using parallels or step jaws, you must select a size that keeps the bottom of the clamped part at or below the top of the movable and stationary jaws.

Always use jaw plates for clamping. If jaw plates are not used, damage to the mounting surface of the movable and stationary jaw will occur. This will result in reduced clamping accuracy and repeatability.

Fig.2

Sketch #2A

Incorrect part  
clamping.

Vise width  
centerline

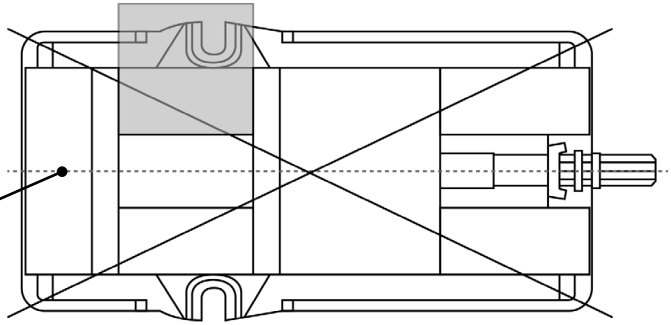

Sketch #2B

Correct part  
clamping

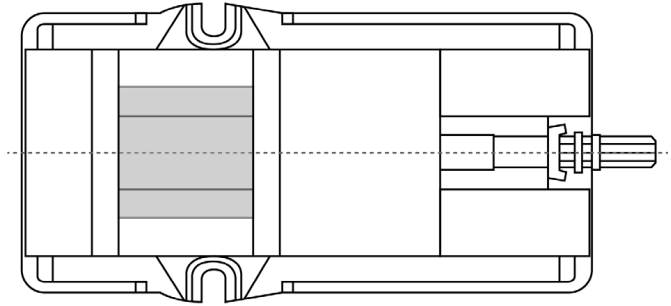

Sketch #2C

Correct part  
clamping

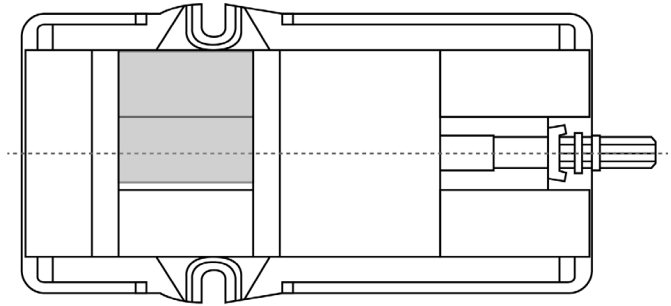

Sketch #2D

Correct part  
clamping

Dummy  
spacer

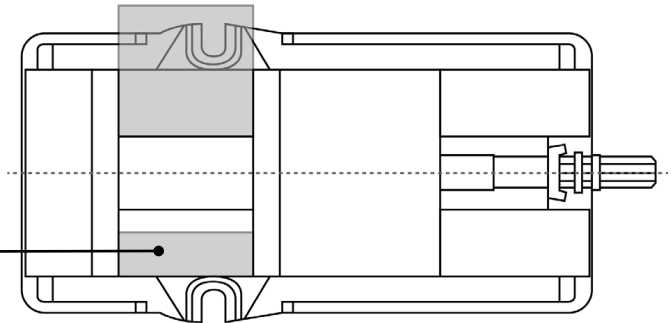

# TRILOCK 3-IN-1 DESIGN

The TriLock 3-in-1 vise adjusts quickly between a double station vise, a large single station vise for large parts, and a small single station vise for small parts.

## Standard Double Station

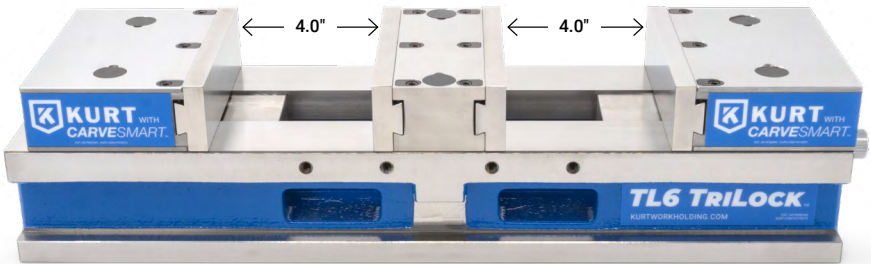

(shown with stock 0.5" hard jaws)

## Small Single Station

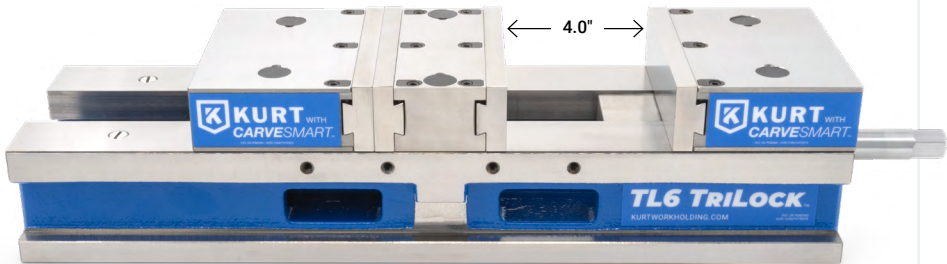

(shown with stock 0.5" hard jaws)

## Large Single Station

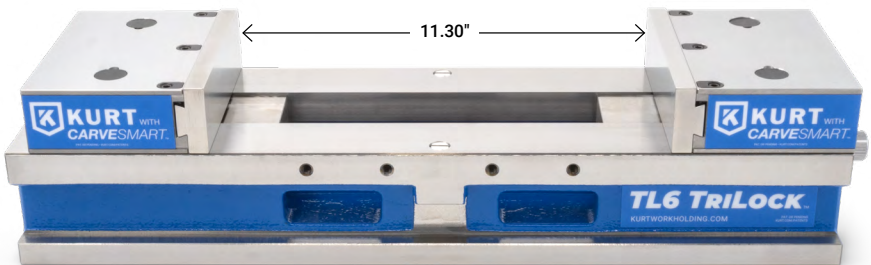

(shown with stock 0.5" hard jaws)



# THIRD HAND FRICTION BLOCK

3-in-1 size adjustments are facilitated with a friction block designed to allow the screw assembly to move freely within the body.

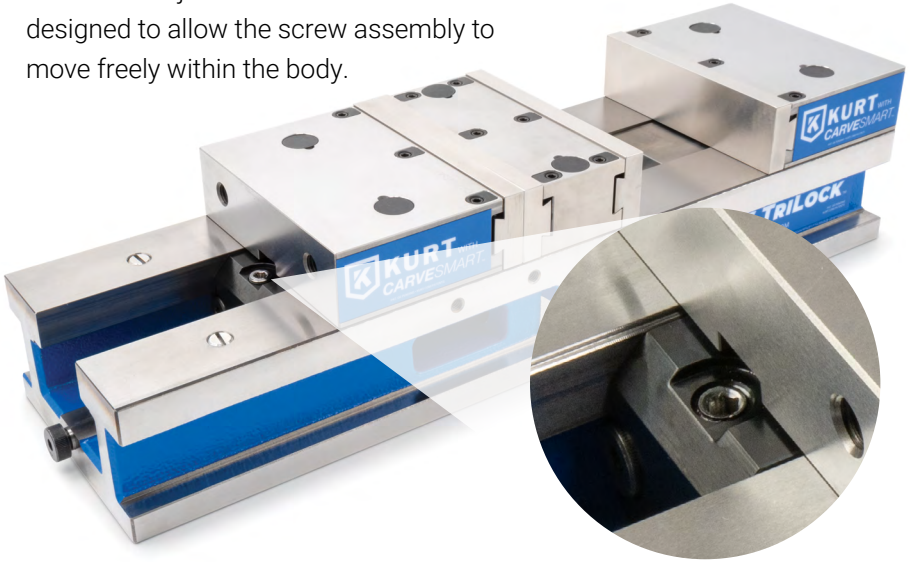

## Using the "Third Hand" Friction Block:

The friction block (also known as the Third Hand) has three tension settings:

- 1. Fully engaged.** This setting locks the friction block/screw assembly in place. Tighten the third hand screw all the way through the middle section to reach full engagement. **NOTE:** When tightening clockwise for fully engaged, do not tighten more than 20 ft-lbs.
- 2. Middle friction setting.** This setting allows for approximately 1 full screw turn of looseness between fully engaged and fully loosened. This setting places friction on the friction block/screw assembly so that it can't accidentally slide out of the vise body but can still be moved by an operator. This is for adjusting between the 3-in-1 vise sizes.
- 3. Fully disengaged.** This setting allows the friction block/screw assembly to move freely in the vise body. It can be used for adjusting between the 3-in-1 vise sizes and is also the setting for cleaning and friction-free screw assembly movement/removal. **NOTE:** When tightening counter-clockwise direction for fully disengaged, do not tighten more than 40 ft-lbs.

# OPERATING INSTRUCTIONS

## Standard Double Station Use:

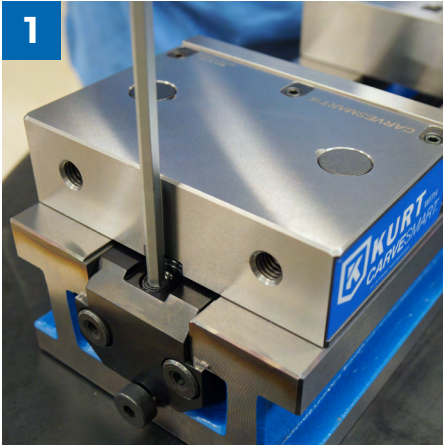

1  
Loosen the friction block screw (third hand) to the fully disengaged position so that the screw assembly can move freely.

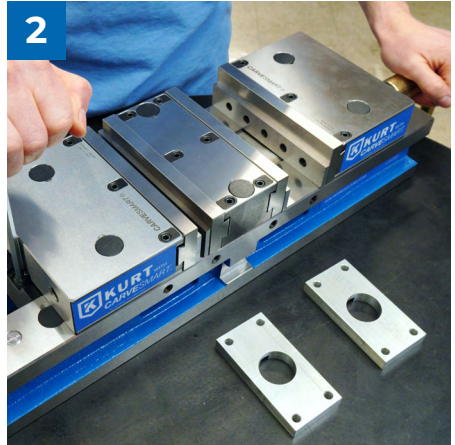

2  
Place parts in the two stations of the vise.

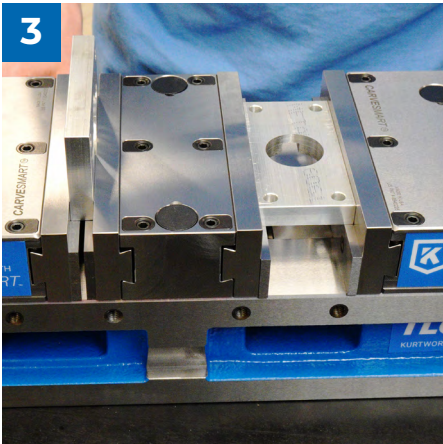

3  
Close vise by rotating the handle clockwise until both jaws come in contact with the parts.

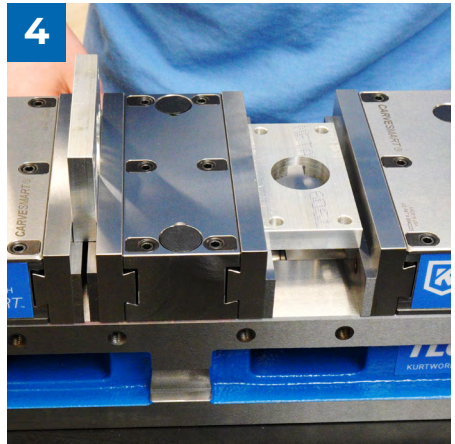

4  
Open vise by rotating the handle counter-clockwise until the front jaw is less than 1/8" from the part.

# OPERATING INSTRUCTIONS

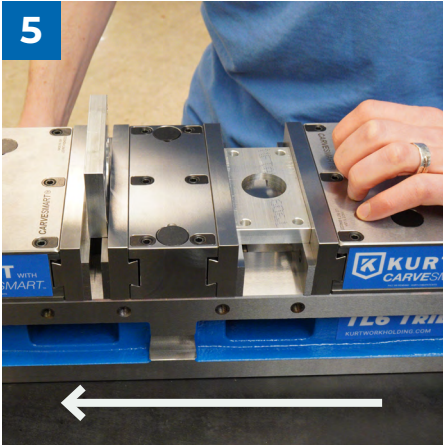

Push the screw assembly toward the back of the vise until the 1/8" gap is in the rear station. This positions the friction block (third hand).

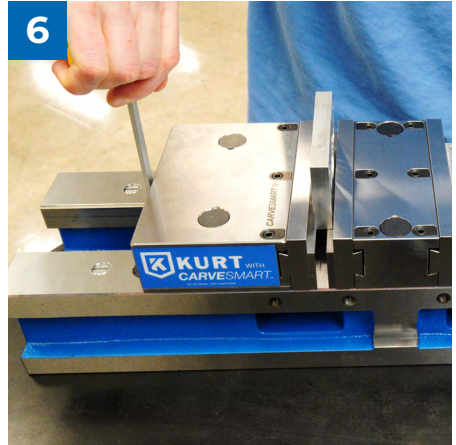

Next, tighten the third hand holding nut all the way to the fully engaged position. This locks the rear nut and allows the vise to open and close on one part at a time.

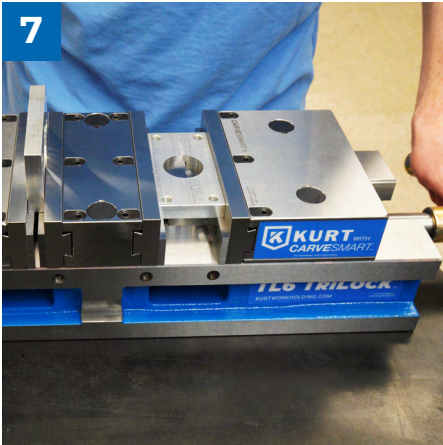

Close the vise by rotating the handle clockwise to clamp the parts. Torque the handle to within the torque range that is listed on page 4 of this manual.

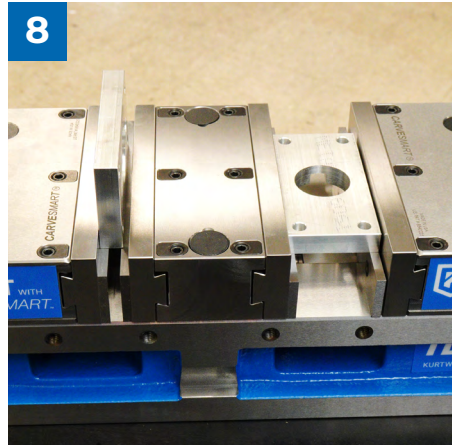

Vise is ready to be used for double station use for this size parts.



# OPERATING INSTRUCTIONS

**Small Single Station Use:** To use this vise as a small single station vise, follow the steps below:

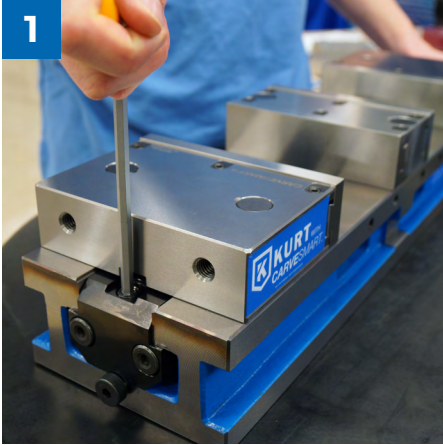

Loosen the friction block screw (third hand) to the fully disengaged position so that the screw assembly can move freely.

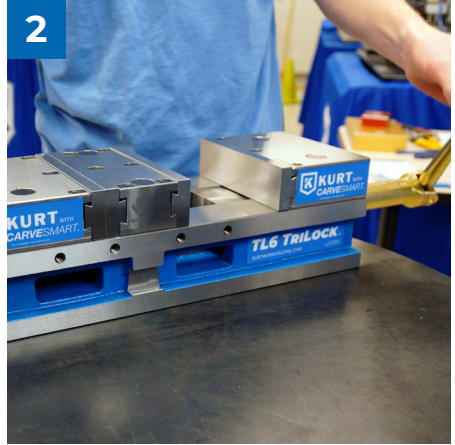

Close the rear jaw by turning the screw handle clockwise until rear jaw makes contact with stationary center jaw.



Tighten the holding block screw (third hand) on the rear side of the vise until hand tight.

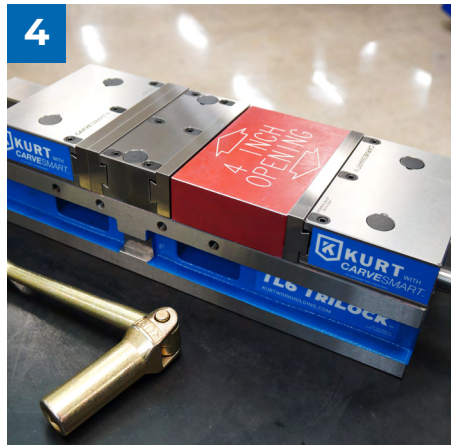

Vise is now ready for small part use.

# OPERATING INSTRUCTIONS

**Large Single Station Use:** To use this vise as a large single station vise, follow the steps below:

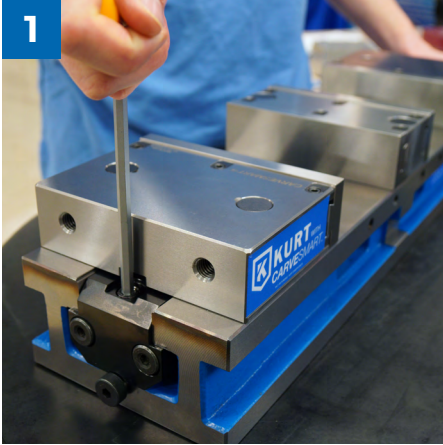

Loosen the friction block screw (third hand) to the fully disengaged position so that the screw assembly can move freely.

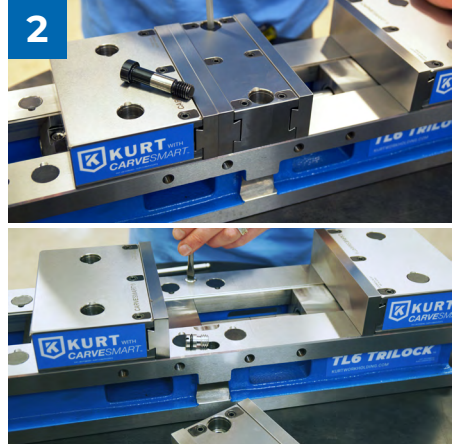

Loosen and remove the locating socket head cap screws from the center stationary jaw. Remove center stationary jaw and set aside. Screw chip guard screws into cap screw holes.

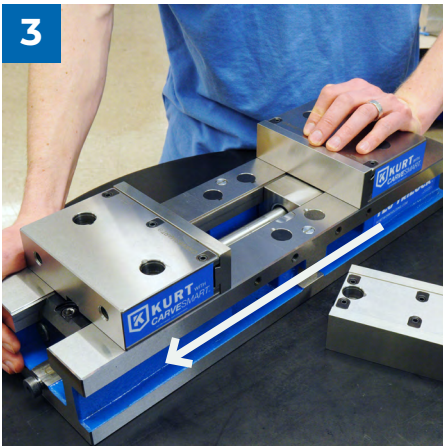

Slide nut and screw assembly towards the back of the vise until the back jaw holes align with the threaded holes in the body.

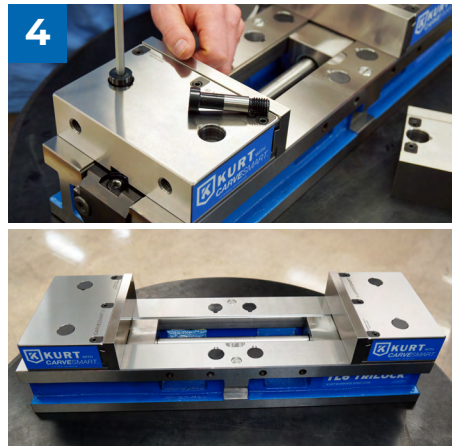

Insert locating screw in the two holes on top of the jaw and tighten down. Replace chip caps. Vise is now ready for large part use.

# CARVESMART JAW OPTIONS

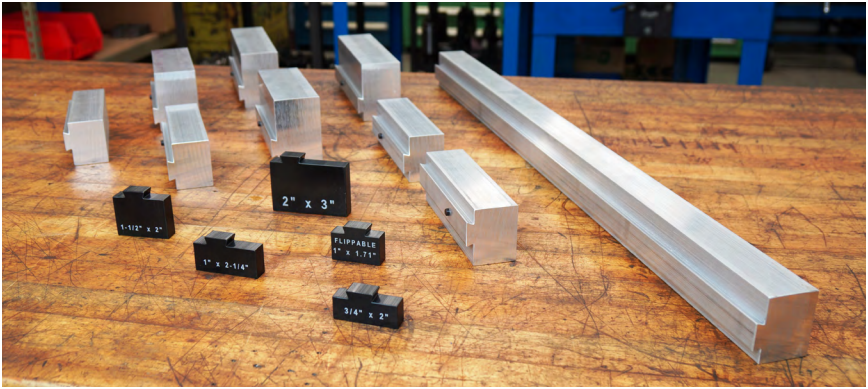

## 6061 Extruded Aluminum Jaws:

Aluminum jaws are available in five profiles and several pre-cut lengths with SmartStops including: 4", 6", and 8" sizes. Also available in 31" and 94" lengths that can be cut to any size.

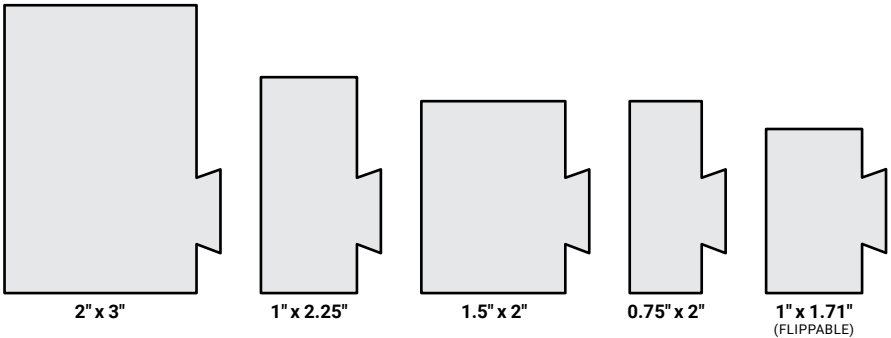

## 1018 Steel Jaws:

1018 cold rolled steel jaws are available in two profiles and several pre-cut lengths with SmartStops including: 4", 6", and 8" sizes. Also available in 31" lengths to cut to any size.

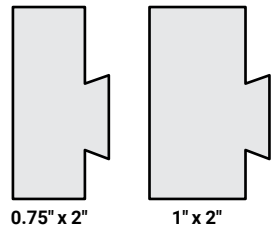



# CHANGING CARVESMART JAWS

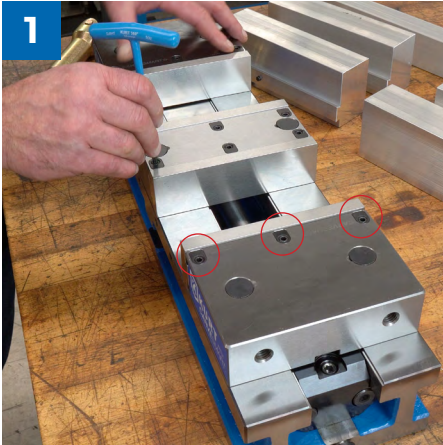

**1** Loosen 3 screws on top of each jaw for each individual jaw plate.

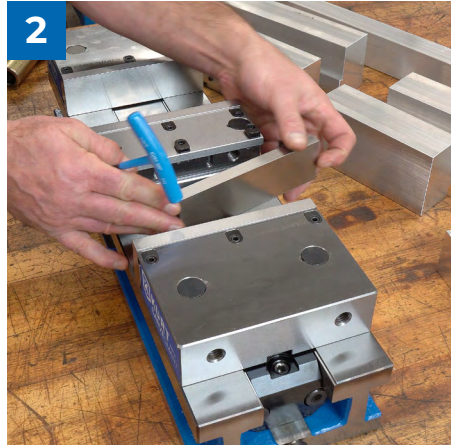

**2** Remove existing plate (if present).

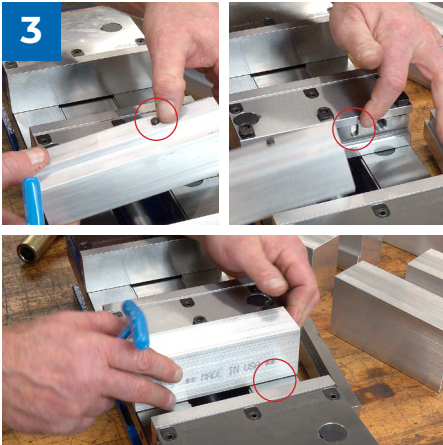

**3** Be sure to align the location pin and that the new jaw plate is flat against vise top.



**4** Then firmly tighten all screws. Do the same with each individual jaw plate and you're ready to go.

Fig.3

## JAW POSITIONING

**Note:** Dimensions below are in inches unless specified.

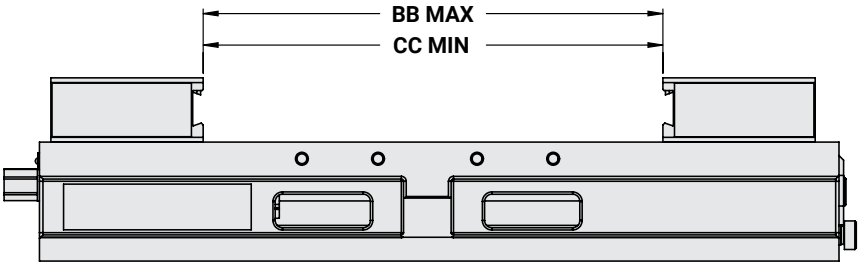
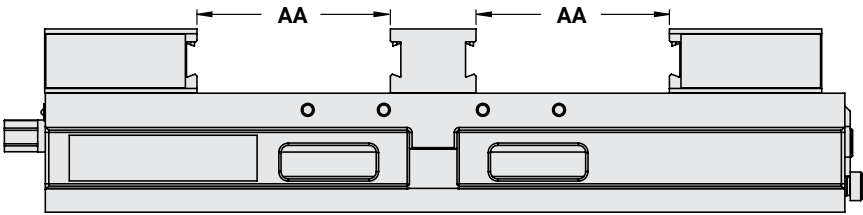

AA	5.07
BB MAX	12.37
CC MIN	7.16



Fig.4

# SIDE & END VIEW

**Note:** Dimensions below are in inches unless specified.

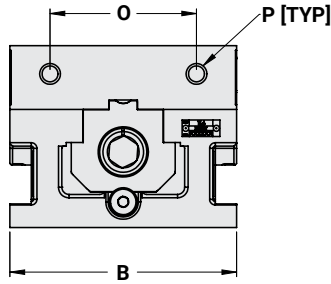
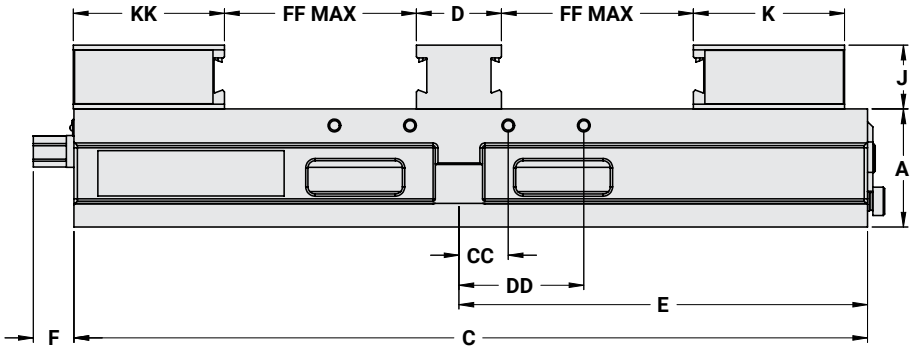

<b>A</b>	3.125
<b>B</b>	6.000
<b>C</b>	21.00
<b>D</b>	2.250
<b>E</b>	10.813
<b>F</b>	1.08
<b>J</b>	1.6875
<b>K</b>	4.00
<b>O</b>	3.875
<b>P</b>	1/2 -13
<b>CC</b>	1.305
<b>DD</b>	3.305
<b>FF Max</b>	5.07

Fig.5

# MOUNTING LOCATIONS

**Note:** Dimensions below are in inches unless specified.

<b>F</b>	1.08
<b>II</b>	3.813
<b>JJ</b>	5.000
<b>MM</b>	2.000
<b>QQ</b>	0.625 (5/8)
<b>SS</b>	3.297
<b>TT</b>	0.46

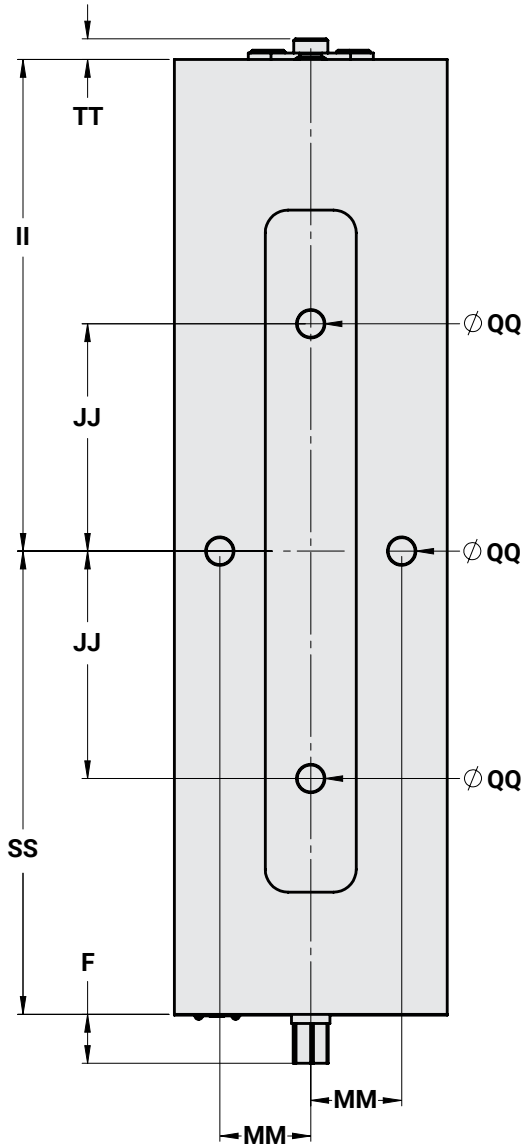

# **SURFACE MOUNT USING SINE KEYS**

Locating the TL6 with keys requires the use of sine keys. Sine Keys are available in several different sizes that are listed on our website at [www.kurtworkholding.com](http://www.kurtworkholding.com). The keys are sold in sets of 2 per package. You can also utilize dowel or step dowels in special cases where sine keys do not work.

## **Mounting:**

The TL6 can be properly located using (2) of the four sine key holes indicated by dimension QQ in Fig.5 on page 18. The TL6 must be clamped on the sides using toe clamps.

# TL6CS PARTS LIST

ITEM#	PART#	DESCRIPTION	QTY.
1	TL6-1	Body, Machined	1
2	TL6CS-2	Movable Jaw	2
3	TL6-3F	Front Nut	1
4	TL6-3R	Rear Nut	1
5	TL6-5	Screw	1
6	TL6CS-6	CarveSmart Style Stationary Jaw	1
7	TL6-14	Protecting Plug	1
8	TL6-18	Shcs, 1/2-20unf X 1.5 Lg Modified	1
9	TL6-19	Shcs, Shoulder	2
10	TL6-20	Shcs, Precision Shoulder 1/2-13	2
11	TL6-21	Shcs, Shoulder	2
12	TL6-87	Spring, Die	1
13	TL6-102	Model/Serial Number Tag	1
14	TL6CS-111	Sticker, Movable	4
15	HDM6-142	Spring Guide	2
16	DX6-169	Wave Spring	3
17	3600V-191-SA	Protective Plug Assembly	6
18	TL6-197	Preload Spring	2
19	D688-211	Internal Brush Seal	3
20	TL6-223	Sticker, Body	2
21	TL6-224	Holding Block	1
22	TL6-225	Friction Shoe	1
23	HD6-267	Spring	2
24	TL6-292	Advanced Mach & Eng. Plug, 0.5"	4
25	80007	CarveSmart Clamp Nut	12
26	80003	CarveSmart Screw	12
27	07-0230	U-Type Drive Screw #2 X 1/4 Lg	2
28	26-0082	Shcs, M5 X 0.8 X 6mm Lg	2

# TL6CS MECHANICAL DRAWING

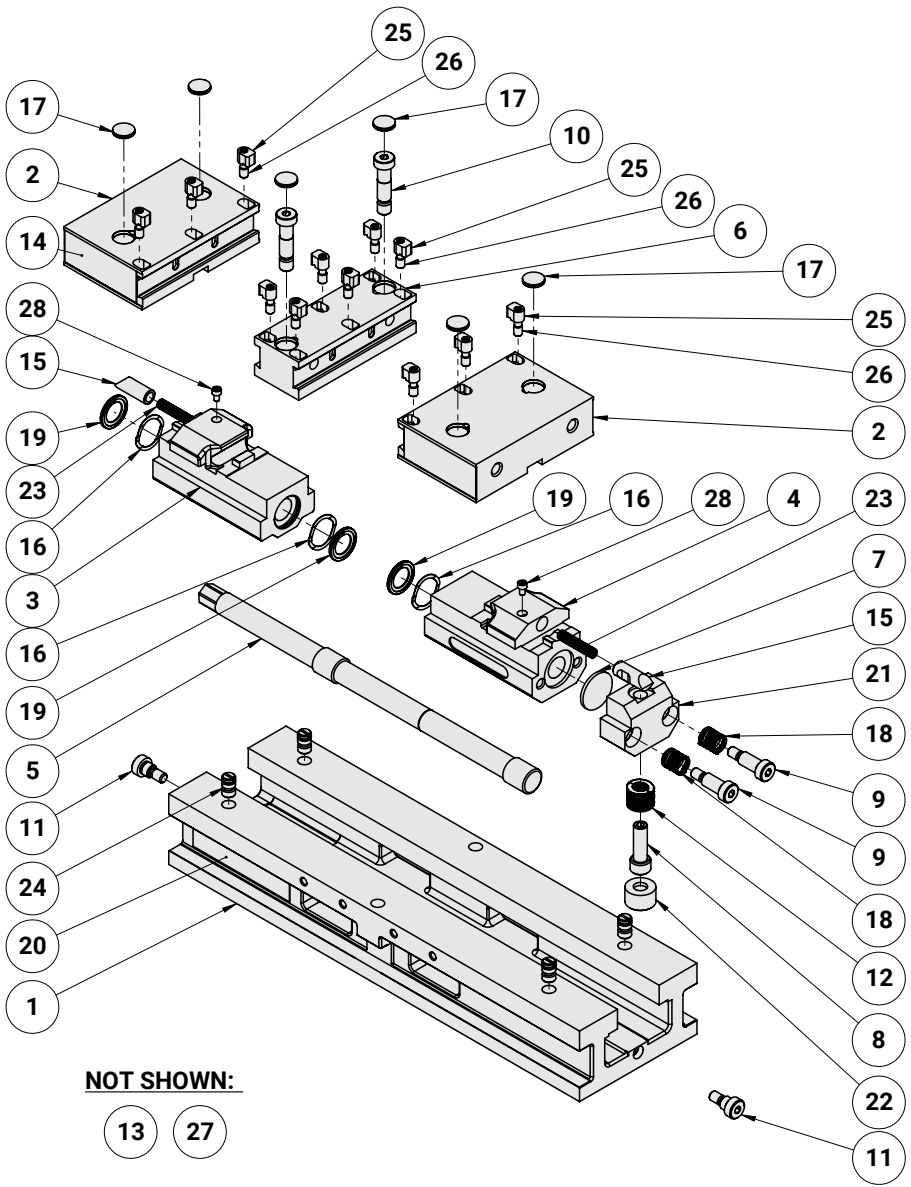

# MAINTENANCE SCHEDULE

Perform regular maintenance to ensure proper operation. Improper maintenance results in poor performance and may void your warranty.

## Daily/ Weekly

1. Remove chips from surface of vise.
2. Visually inspect seals for damage and cleanliness.
3. Visually inspect for chip entrapments and remove when necessary.
4. Air-dry and apply rust inhibiting oil to the machined surface of the vise.

## Monthly (watch informational video)

1. Open the vise to the maximum opening.
2. Slide the movable jaw (#2, Fig.6 pg 21) slightly toward the stationary jaw and lift up to remove the jaw from the "beak" of the nut.
3. Turn the movable jaw over and clean the inside cavity.
4. Remove the button head cap screw (#11, Fig.6) in front of the vise body.
5. Fully loosen the third hand friction block screw (#8, Fig.6) to allow the nut and screw assembly to slide freely inside the vise body.
6. Slide the nut and screw assembly out of the vise body.
7. Remove chips, clean body cavities and apply a light coat of machine oil to the machined surface of the following item:
  - a. Nut and screw assembly (clean exposed threads on the screw)
  - b. Bed of vise (top of "rails")
  - c. Inside of the vise between the center ways.
8. Slide the nut and screw assembly into the vise body and screw in the button head cap screw (#11, Fig.6).
9. To re-assemble the movable jaw, press down on each of the quick jaws to lock into place
10. Your vise is ready. Open and close to check for proper operation.



### WATCH PRODUCT SETUP VIDEO

Scan Code with  
Phone Camera

# TROUBLESHOOTING TIPS

If properly maintained, the Kurt TL6 TriLock Vise will operate trouble free for many years. In some cases it will be necessary to troubleshoot. Use the information below to help in the process.

**Problem:** My vise turns hard.

**Tip:** As a new vise the brush seal could be stiff. Allow for break in of vise.

**Tip:** As a used vise, it could be filled with chips and threads could be jammed. Properly clean and grease vise.

**Problem:** My vise will not turn in either direction.

**Tip:** The vise is jammed with debris. Disassemble and clean as needed.

**Problem:** My vise won't hold tolerance.

**Tip:** You may be experiencing jaw lift from clamping too high or on one side of the jaw. Lower the part in the vise jaw and clamp more material.









**A**ll Kurt Manufacturing Company industrial workholding products and parts with the exceptions noted below, are warranted against defects in material and workmanship for the life of the product or part. (The life of the product is defined as that point in time when such item no longer functions due to normal wear and tear.) Failure to properly maintain and/or properly operate the product or part that has been worn out, abused, heated, ground or otherwise altered, used for a purpose other than that for which it was intended, or used in a manner in consistent with any instructions regarding its use. The sole obligation of Kurt Manufacturing Company, Inc. (Kurt) and the purchaser's **SOLE AND EXCLUSIVE REMEDY** hereunder, shall be limited to the replacement or repair of any Kurt product or part (by an authorized Kurt technician) which are returned to Kurt Manufacturing Company's place of business or any authorized service center, transportation, shipping and postal charges prepaid, and there determined by Kurt Manufacturing Company to be covered by the warranty contained herein.



THE LIMITED WARRANTY DESCRIBED HEREIN IS MADE EXPRESSLY IN LIEU OF ANY OTHER EXPRESSED OR IMPLIED WARRANTIES, INCLUDING ANY IMPLIED WARRANTY OF MERCHANTABILITY OR FITNESS FOR A PARTICULAR PURPOSE. KURT MANUFACTURING COMPANY IS NOT RESPONSIBLE FOR THE IMPROPER USE OF ITS PRODUCTS. KURT SHALL NOT BE LIABLE FOR ANY DIRECT, INDIRECT, INCIDENTAL SPECIAL OR CONSEQUENTIAL DAMAGES, INCLUDING BUT NOT LIMITED TO, LOSS OF USE, REVENUE OR PROFIT.

KURT ASSUMES NO LIABILITY FOR, AND MAKES NO WARRANTY REGARDING ANY PURCHASE ITEMS WHERE THE MANUFACTURER OF SUCH ITEM EXTENDS A SEPARATE WARRANTY.



**KURT** WORKHOLDING

Thank you for your  
purchase! If you have any  
feedback or questions  
please contact us:

**Kurt Industrial Products // A Division Of Kurt Manufacturing**

9445 East River Road NW | Mpls, MN 55433  
Phone 763-574-8309 | Toll Free 877-226-7823  
Fax 763-574-8318 | Toll Free Fax 877-226-7823

[kurtworkholding.com](http://kurtworkholding.com) | [workholding@kurt.com](mailto:workholding@kurt.com)

Manual Revision:  
05.10.2024